

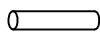









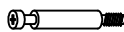

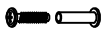
- K10 HS300 V:720
- K11 HS450 V:720
- K12 HS600 V:720
- K13 HS900 V:720
- K16 HS300 V:1000
- K17 HS450 V:1000
- K18 HS600 V:1000
- K23 HS150 V:720
- K24 HS150 V:1000

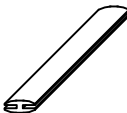
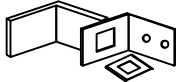
A	x8	B	x8	C	x8	D	x8	F	x35
									
G	x2	H	x8	J	x8	K		L	x2
				$\varnothing 5 / \varnothing 13\text{mm}$ 					
								Q	x4
								3,5x16mm	
									

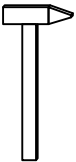
		 $\varnothing 5,5$		 30 min	
---	---	--	--	---	---

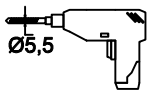
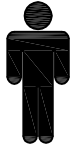

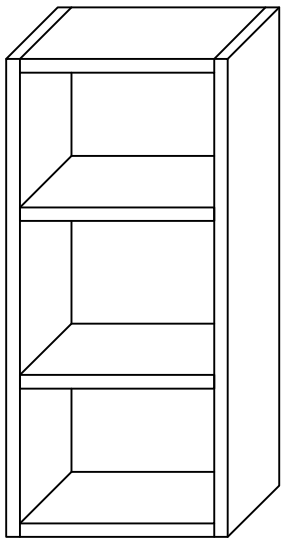
1.

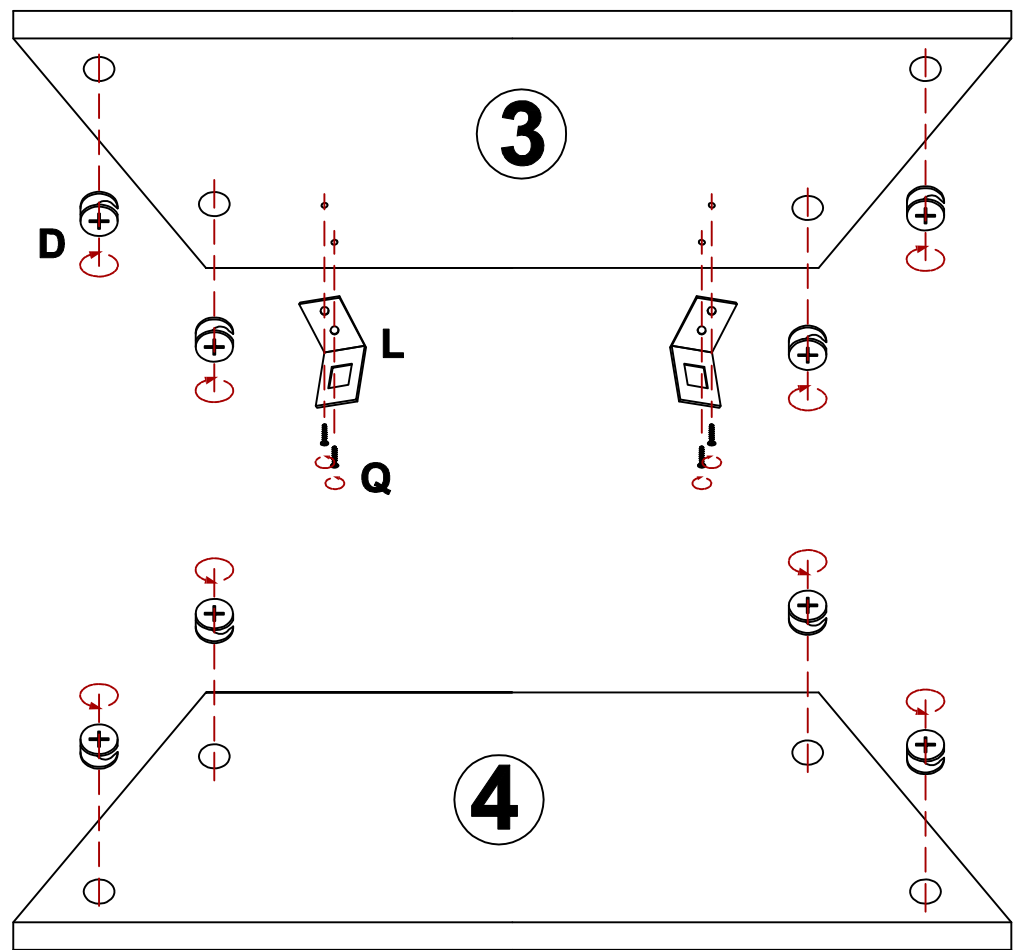

2.

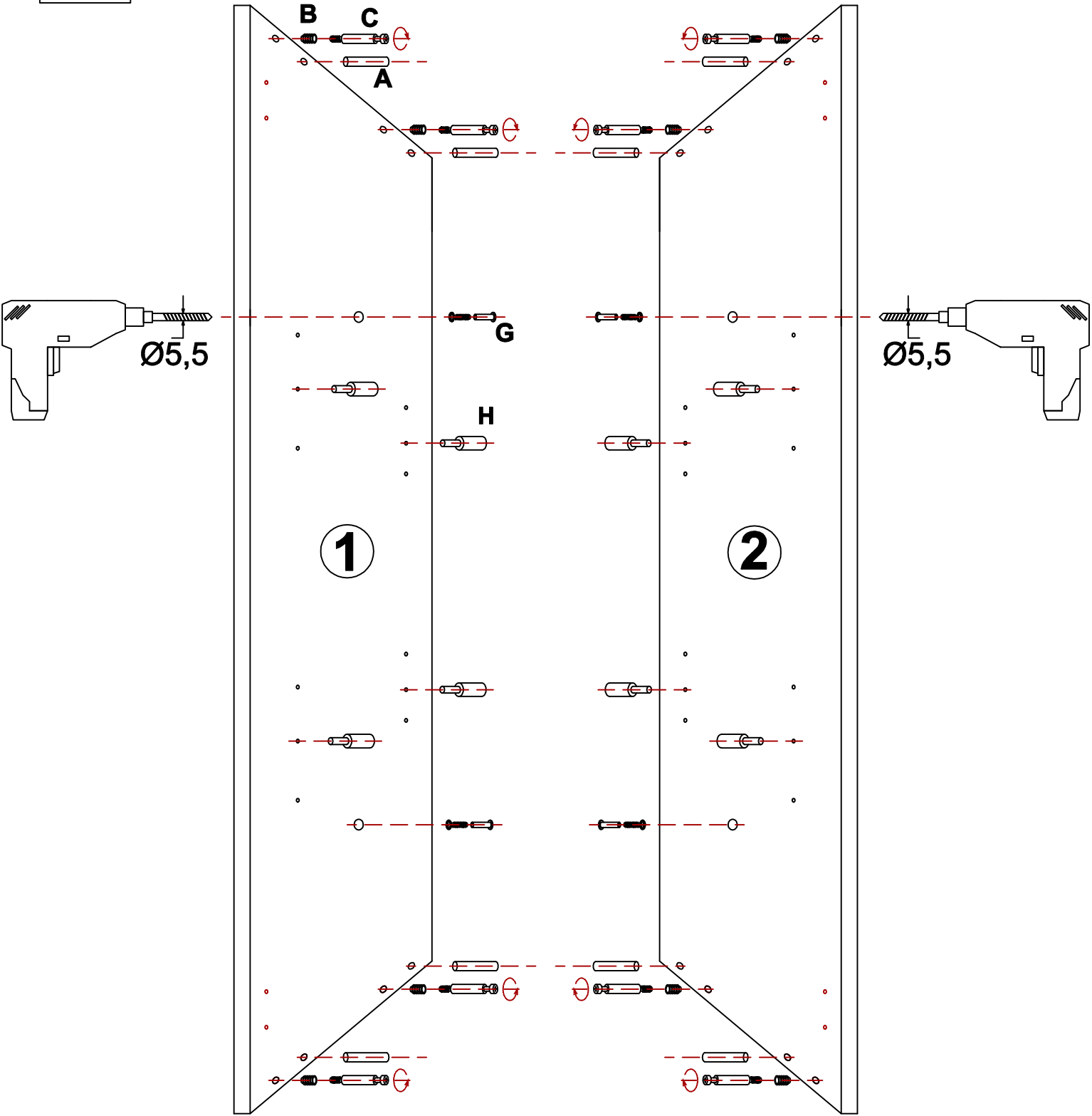

3.

K10 HS300 V:720
K16 HS300 V:1000
K23 HS150 V:720
K24 HS150 V:1000

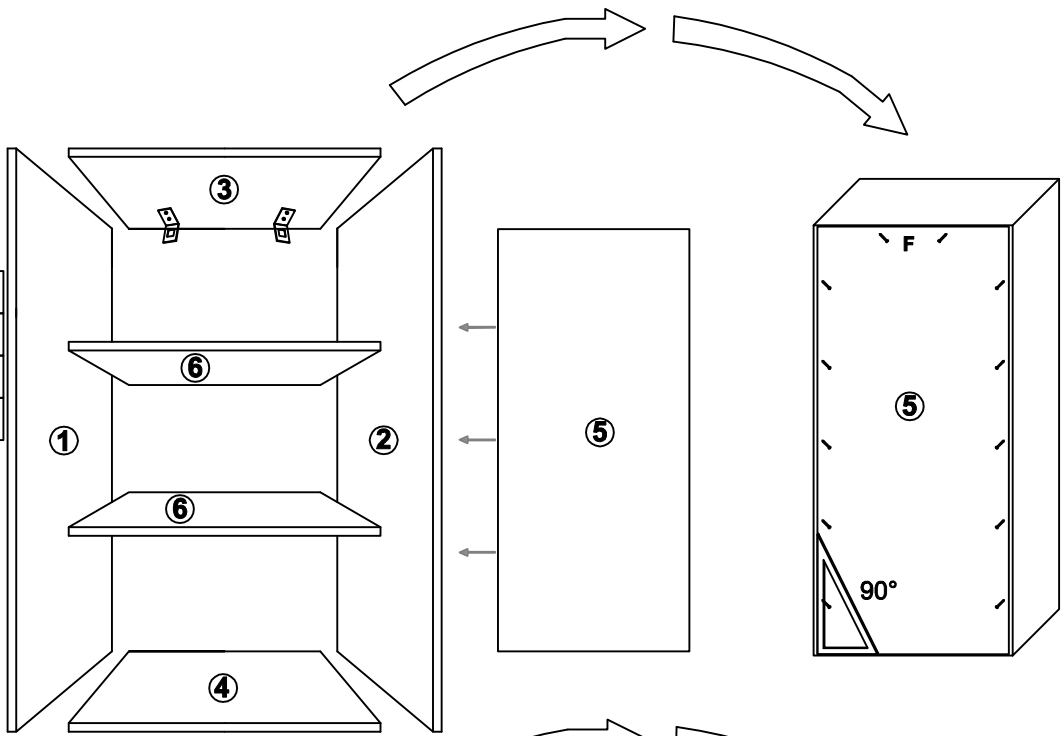

3.

K11 HS450 V:720
K12 HS600 V:720
K17 HS450 V:1000
K18 HS600 V:1000

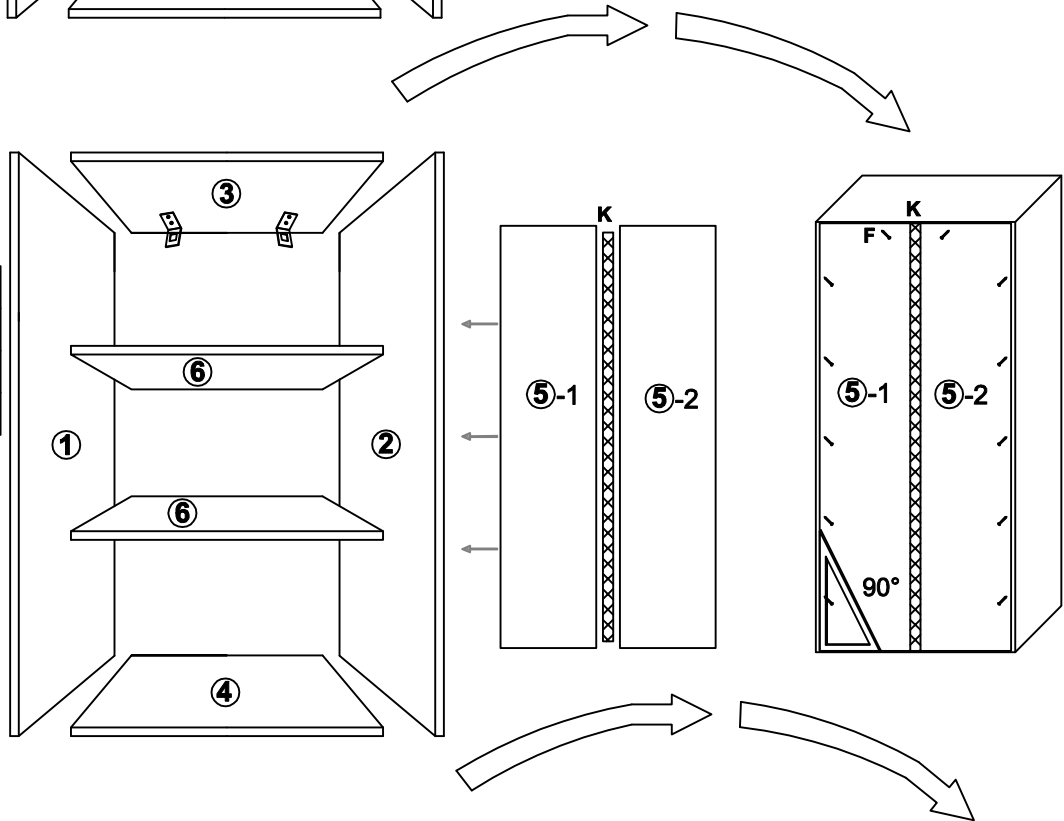

3.

K13 HS900 V:720

